

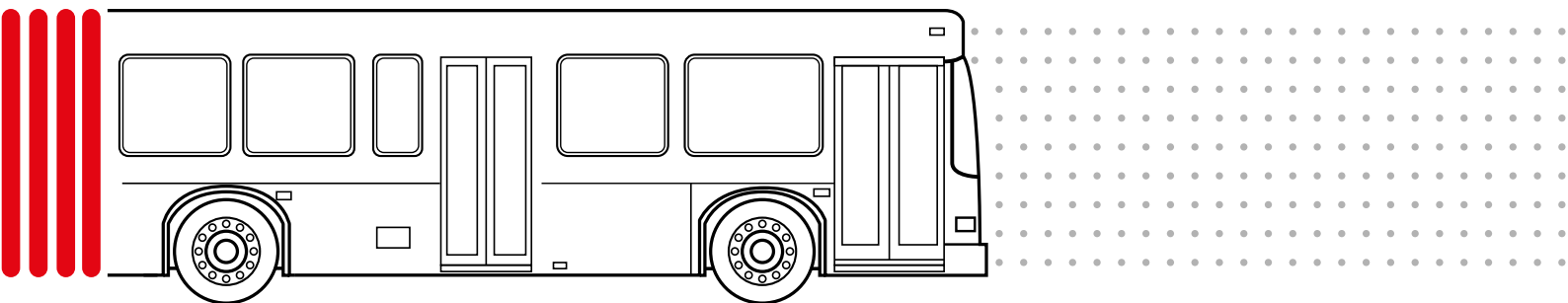

**PEI  
MOBILITY**  
*Performing gangway*

*Interconnection Solutions*

**PRODUCT CATALOG**







# PEI MOBILITY

*Performing gangway*

The **Partner** for all kinds of **Gangway**.  
Especially **yours**.

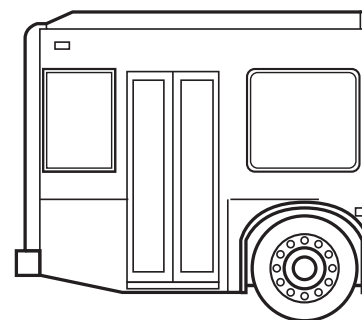

# COMPANY PROFILE



## ABOUT P.E.I. srl

The strategy of success of the P.E.I. emerged from the intuition of the founding partners in recognising the importance of workplace safety, which has led, since the 1980s, to the significant development of the market for protective covers in machine tools.

With 420 employees located in 7 production sites between Italy and abroad, 70 international patents, and a sales network that covers all of Europe and much of the rest of the world, PEI Group is renowned for its propensity to innovate and for its technology research.

Over 4% of the turnover is dedicated to investment in R&D focus of environmental and sustainability impacts.

The commercial structure consists of a widespread network of commercial technicians and thus guarantees coverage across the whole of Italy and Germany as well as a major part of the rest of Europe.

Production plant has obtained ISO 14001:2015 certification.

## OUR HISTORY SO FAR

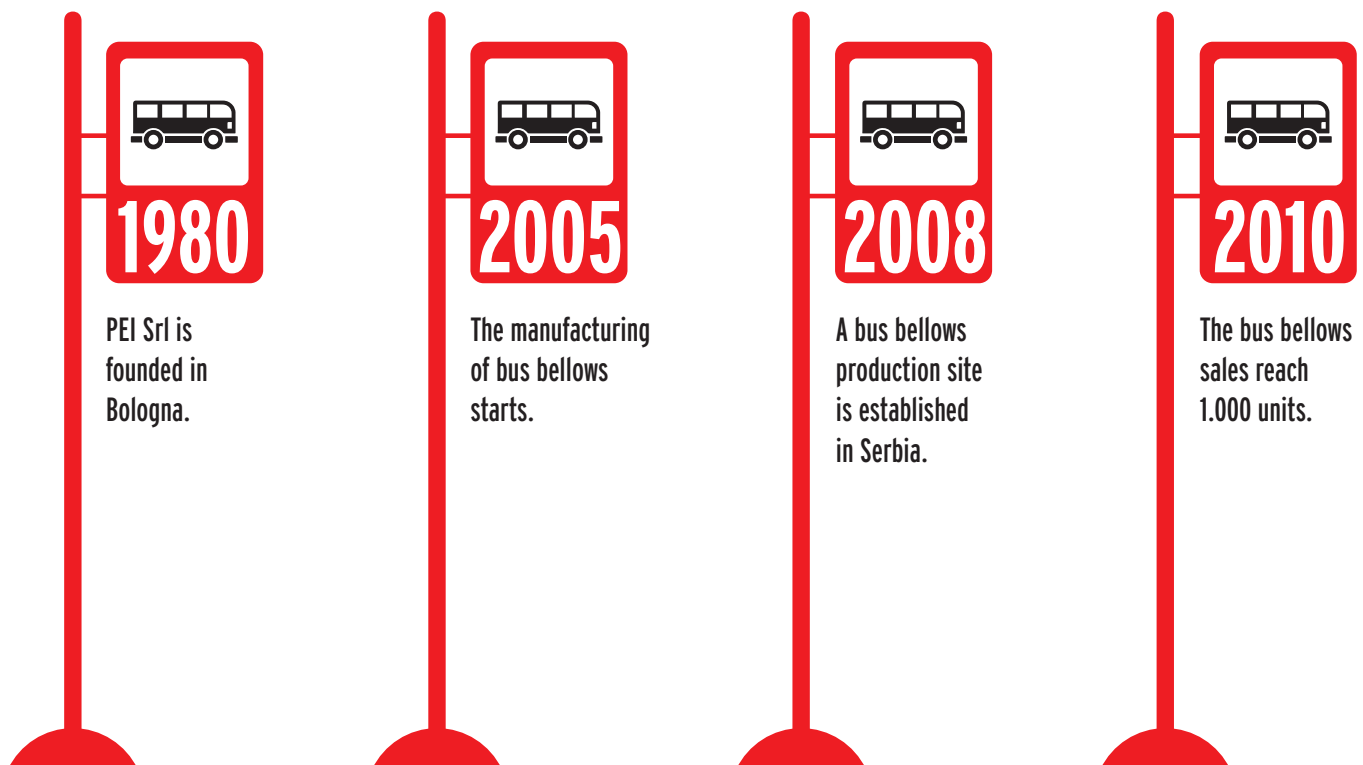



## ABOUT US

PEI Mobility is a brand of P.E.I Srl and it was founded in 2005, when the group decided to start manufacturing bellows for articulated buses.

Years of activity and success in the sector have led PEI Mobility to currently count over 10.000 bellows in Europe and around the world, earning it a leading position in the international scenario.

A result also achieved thanks to the help of the two foreign production plants, one in Serbia and the other in Brazil, which report to the headquarters in Bologna.

PEI Mobility's full range of articulations is suitable for every type of chassis and is manufactured according to most innovative production techniques.

PEI Mobility offers bespoke solutions that meet customers' needs and guarantee maximum safety, endurance, and ease of maintenance.

Flexibility and efficiency are ensured by extensive engineering experience, advanced R&D, quality certifications and stringent testing procedures.

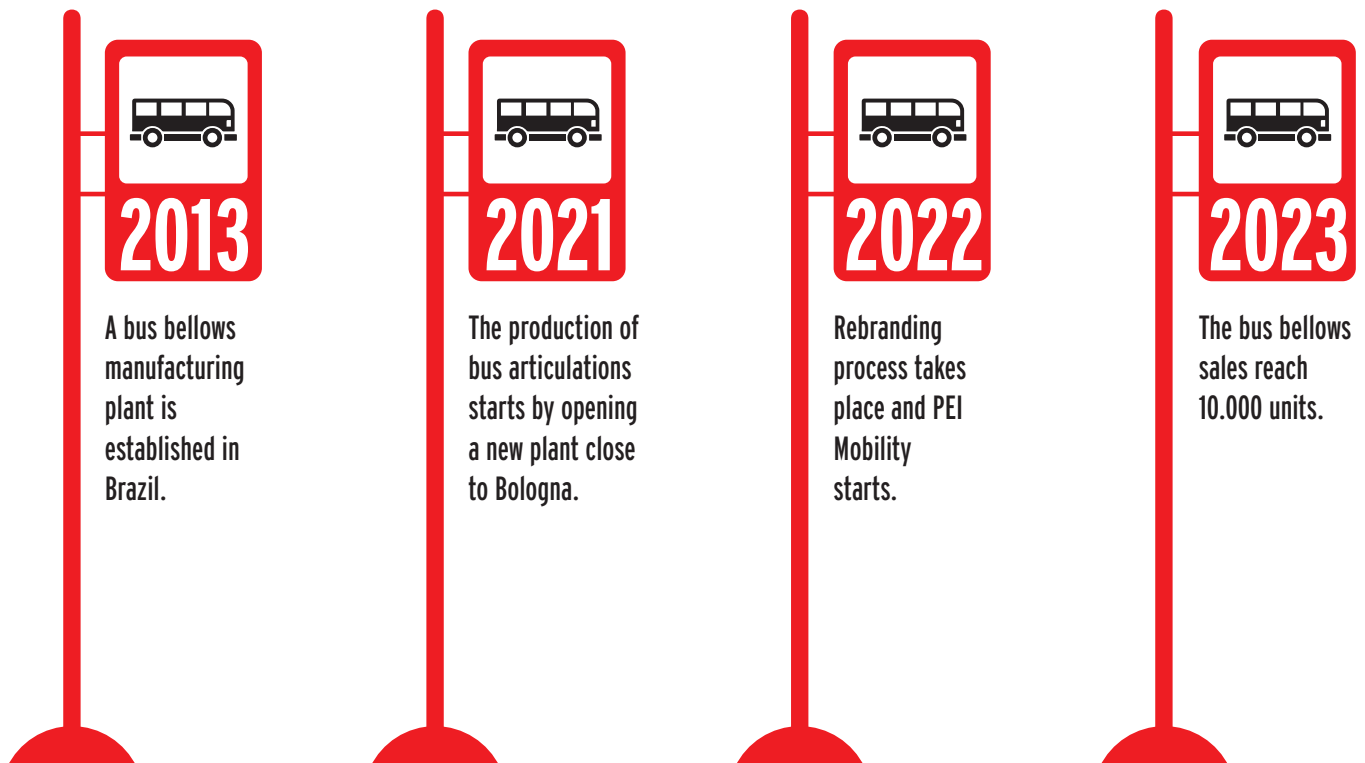



# COMPLETE GANGWAY

Complete technologically advanced interconnection system to increase the overall efficiency of the articulated bus.

## **Fabric**

*Bellows made of UV-resistant copolymer, complying with the highest safety and application certificates in the automotive field.*

## **EGS: Energy Guiding System**

*External hose guiding system. Designed for high-voltage cables of electric vehicles with fixing brackets ready for assembly of all cables between carriages.*

## **HGS: Hoses Guiding System**

*Internal complete hose guiding system with fixing brackets ready for assembly of all cables between carriages.*

**Upright** - made of self-supporting extruded aluminium and featuring an ergonomic design and patented internal quick-fit system.

## **Articulation**

*Articulation in steel and composite material, complete with hydraulic control system of stability.*

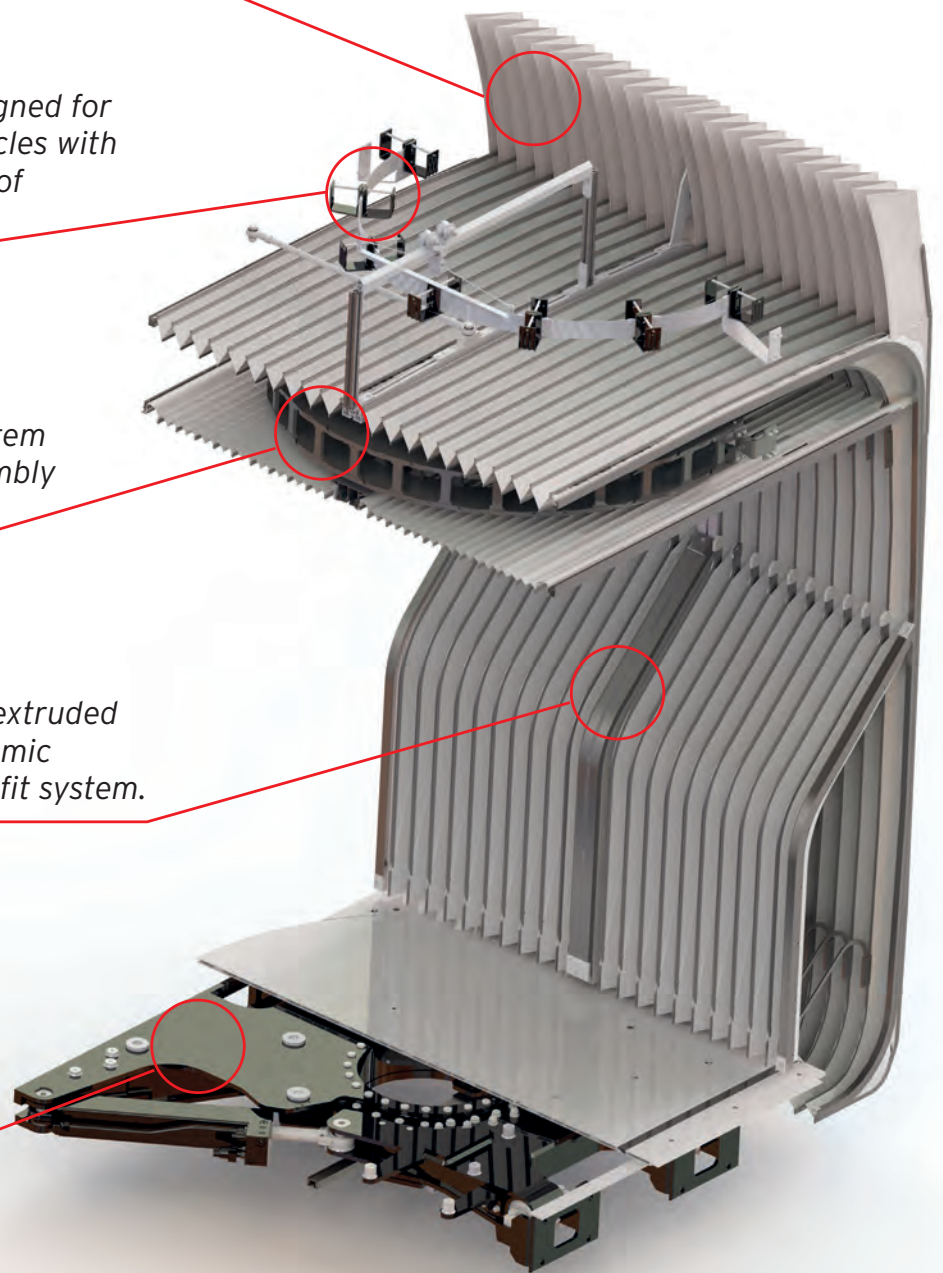





# ARTICULATION SYSTEM FOR BUSES

PEI Mobility's range of articulations includes models suitable for all kinds of chassis.

We have designed and produced articulations with forward and backward pitch axis, in order to serve both market standards, and we propose ourselves as a universal partner for all manufacturers of articulated buses.

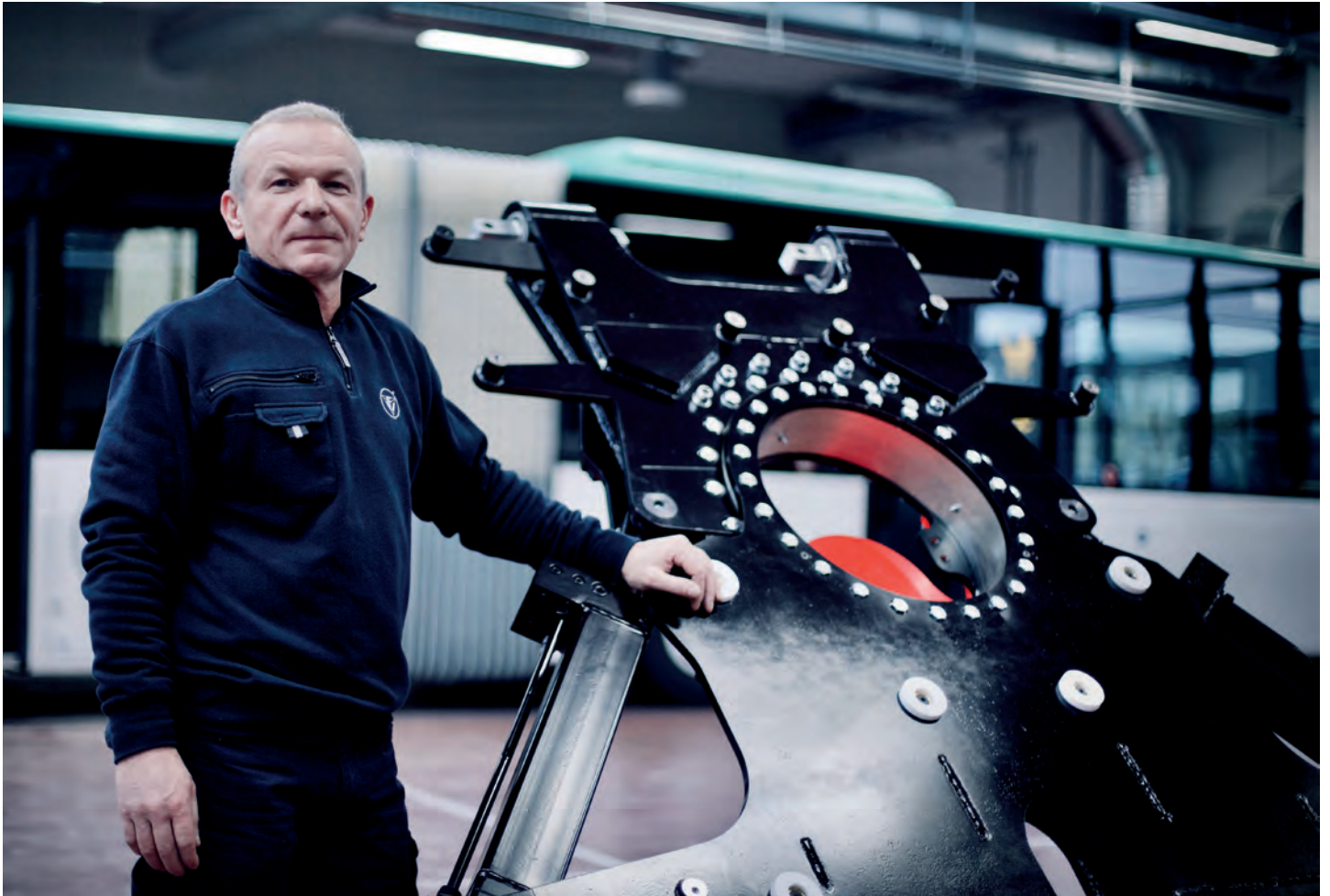

Efficiency and innovation are the keystones on which our R&D and production departments focus their experienced work to offer high quality products to the market.

With a view to technological improvement, we have designed steel articulations, which are market standard, and articulation with carbon-fibre parts, a brand new addition in this sector.



# MECHANICAL SIMULATION

The dynamic simulation in vehicle design is an important virtual analysis and testing tool that has been supporting physical tests made in automotive industry for a long time now.

In particular, the sector of urban bus design is a theme of great interest for research in the automotive world, both in terms of performing features and considering safety and comfortable mobility for passengers.

In this specific context, the R&D department of PEI Mobility has been working for a long time now with special state-of-the-art multi-body software to create solutions with the primary aim to optimise road transport.

Through the **MBD** software (Multibody Dynamics) the road roughness can be reproduced and this allows virtual testing of the articulation's road behaviour.

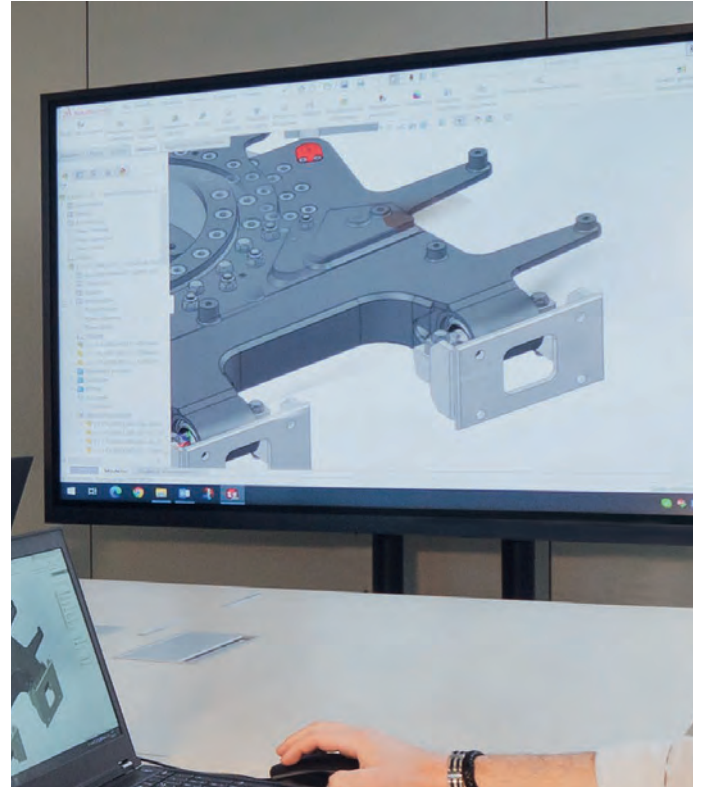

The software actually reproduces every part of the bus chassis to be tested: from the axle, to the carriages up to even the passengers themselves.

It provides the required dynamics and responses about vehicle instability if specific adverse situations occur.

Therefore, the dynamic simulations allow us to examine the performance of the hydraulic damping system by predictive testing.

The safety parameters established by the most authoritative safety certification bodies are our imperative.





# STABILITY CONTROL UNIT

The bus articulation systems of PEI Mobility are supplied with microprocessor-controlled electronics.

The Stability Control Unit (SCU) communicates with the vehicle and allows real-time adjustment of the hydraulic system, adjusting the vehicle's behaviour in potentially critical situations.

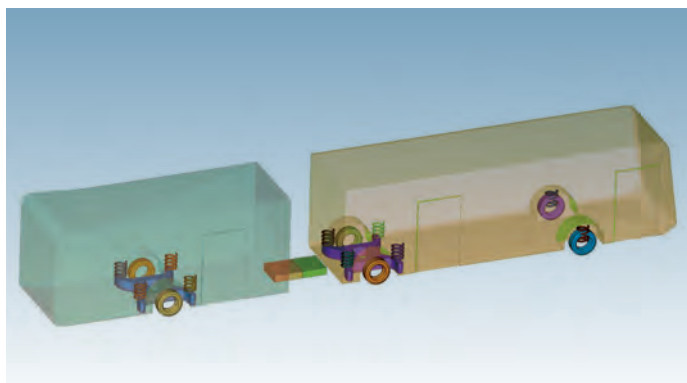
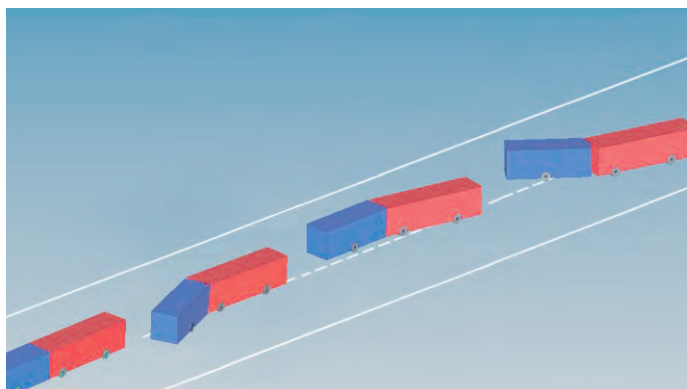

Making use of dynamic simulation software and thanks to great vocation for technological development, PEI Mobility is able to adjust each damping device according to the structure of the vehicle it will serve.

PEI Mobility thus commits to solve one of the main issues related to the design of buses, the event known as "Jackknife", typical of the articulated vehicles.

In this field, this term represents a dangerous operation condition that leads to loss of trailer control and compromises the stability of the vehicle trajectory.



# ARTICULATIONS FOR ALL BUS TYPES

## W695

### WELDED STEEL ARTICULATION

Welded sheet metal articulation: extensive range of customisation options offered to meet all market requirements.

Innovative, patent-protected bearing fastening system ensures more efficient operation and consequently a lighter structure.

Independent shock absorbers ensure better vehicle stability control.

Elastic joints offer better vibration damping, resulting in greater passenger comfort.

Suitable for both low- and high-floor buses.

Fastening systems featuring sliding pads guarantee platform a long working life.

Special fastening systems for self-lubricated cylinders mean low maintenance.

Weight: 550 kg.



## W350

### WELDED STEEL ARTICULATION

Welded sheet metal articulation: extensive range of customisation options offered to meet all market requirements.

Compact version, with smaller slewing ring.

Independent shock absorbers ensure better vehicle stability control.

Elastic joints offer better vibration damping, resulting in greater passenger comfort.

Suitable for both low- and high-floor buses.

Fastening systems featuring sliding pads guarantee platform a long working life.

Special fastening systems for self-lubricated cylinders mean low maintenance.

Weight: 495 kg.

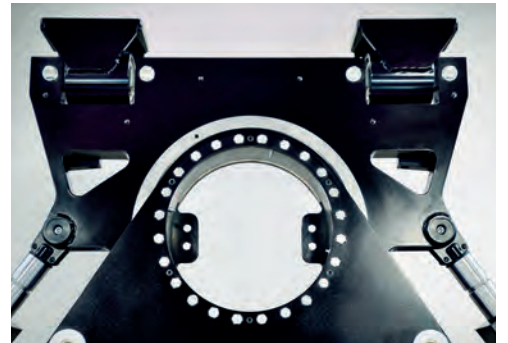
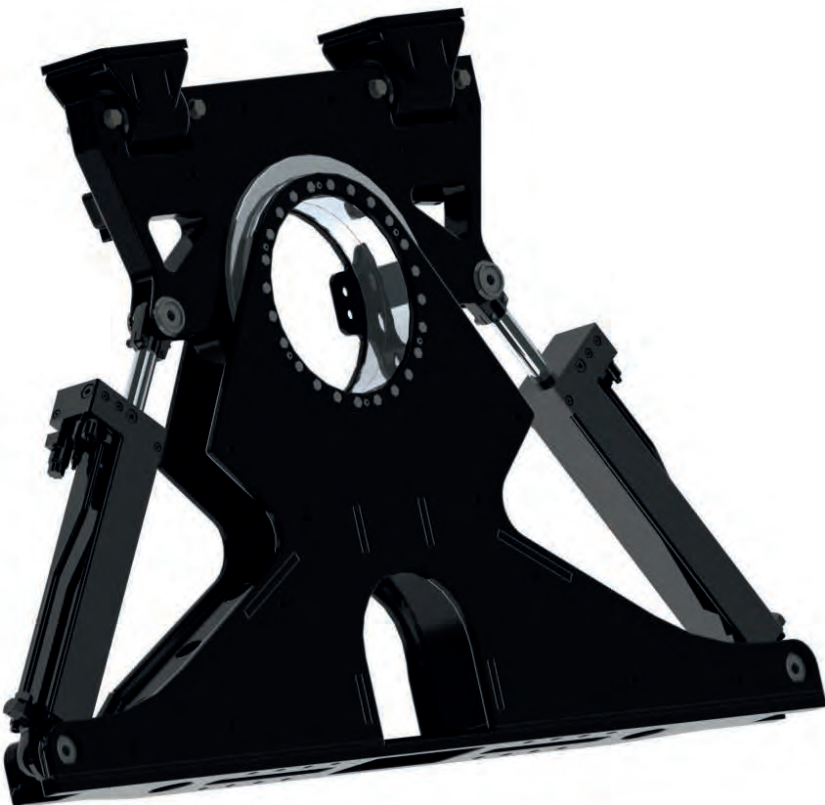



# LOOKING AHEAD

The PEI Mobility R&D department has embarked on a journey into the future, through technology and production, heading for sustainability, efficiency, and innovation.

The latest innovation mainly concerns the use of **SMC** (Sheet Moulding Compound) technology in the design and construction of articulations.

The use of carbon fibre means joints are significantly lighter, which translates into lower fuel consumption, greater fuel autonomy, and less pollution.

The technology of these joints, which are currently in the prototype stage, is based on the combined use of carbon and steel.

## CW695

### CARBON FIBRE AND STEEL ARTICULATION

Use of carbon fibre together with conventional materials means joint offers unparalleled lightness and exceptional performance.

Carbon fibre structure is assembled using certified structural adhesive.

Independent shock absorbers ensure better vehicle stability control.

Elastic joints offer better vibration damping, resulting in greater passenger comfort.

Suitable for both low- and high-floor buses.

Fastening systems featuring sliding pads guarantee platform a long working life.

Special fastening systems for self-lubricated cylinders mean low maintenance.

Weight: 170 kg lighter than equivalent products.





PEI Mobility's **NEW CONCEPT** is based on advanced technology, an articulation **WITH CARBON FIBRE**.



## New concept

## Advanced technology



### CARBON FIBRE PRODUCTION TECHNOLOGY

Innovative **SMC** (Sheet Moulding Compound) technology combines the advantages of carbon fibre, such as lightweight design and strength, with those of a fast, industrialisable process like press moulding. Use of short fibres allows the creation of components with complex shapes keeping low costs and ensuring more efficient use of material.

The automated process guarantees products that remain the same over time, in terms of both shape and performance.





# ARTICULATION FOR PULLER VEHICLES

New joint dedicated to 'puller' vehicles with a different traction system.

For this category of buses, a simpler articulation, which does not require a specific damping system and a stability control device, can be anyway effective.

PEI Mobility has thus introduced a more essential, but technologically advanced product, able to meet all the needs in this category of vehicles, currently mainly represented by full electric buses and Bus Rapid Transit (BRT) systems.

## W695P

### WELDED STEEL ARTICULATION

Welded sheet metal articulation: extensive range of customisation options offered to meet all market requirements.

Innovative, patent-protected bearing fastening system ensures more efficient operation and consequently a lighter structure.

Elastic joints offer better vibration damping, resulting in greater passenger comfort.

Suitable for both low- and high-floor buses.

Fastening systems featuring sliding pads guarantee platform a long working life.

Weight: 450 kg.

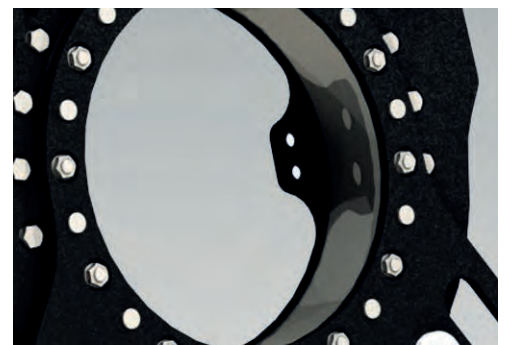
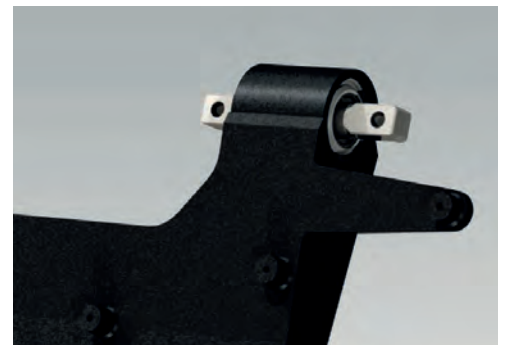



## ENDURANCE TESTS

In our production plant is present a testing laboratory equipped with high specialized instrumentation, which allows us to perform tests on the products in both the R&D and production phases.

The use of advanced equipment and latest generation benches, characterised by automation and interconnection systems, are referred to Industry 4.0 hallmarks.

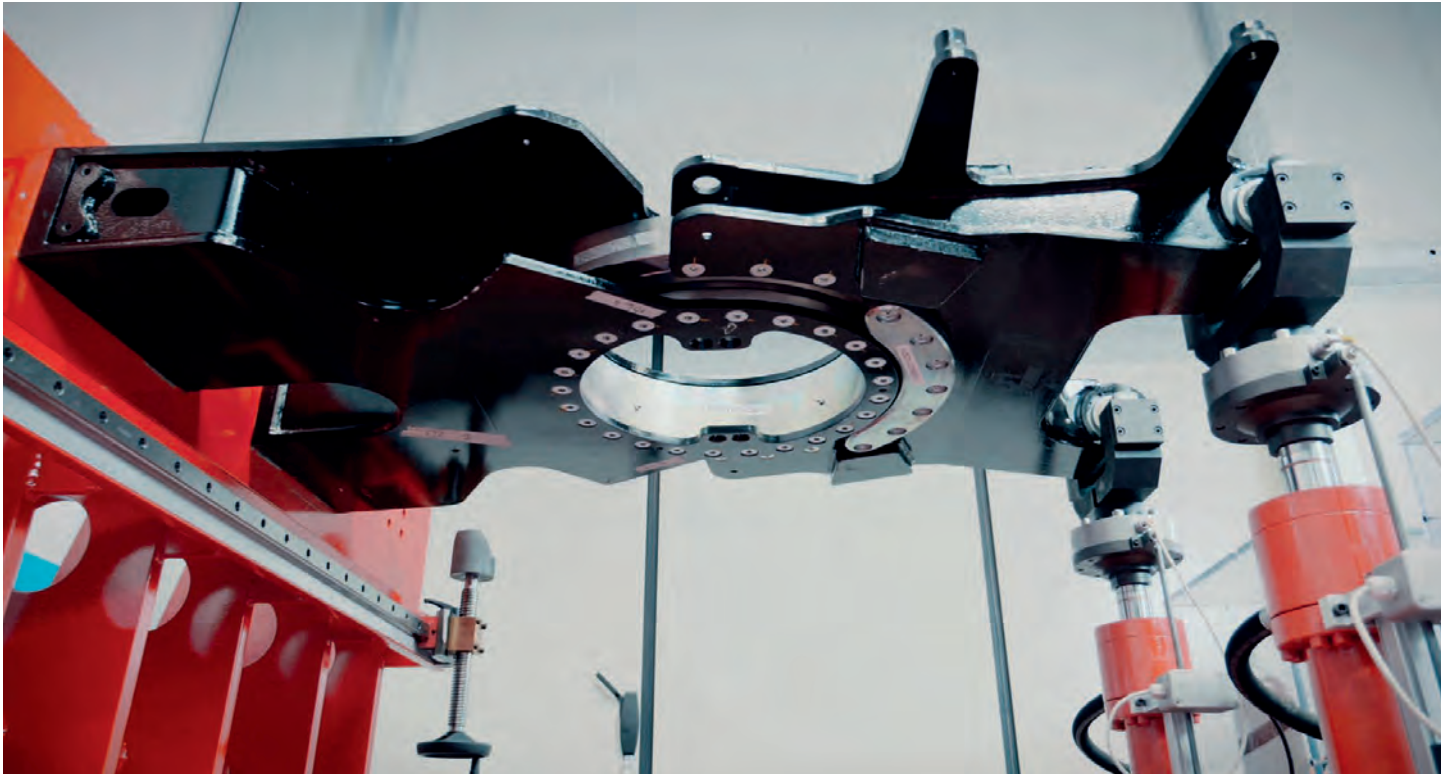

We can thus assess the strength and fatigue states of the materials and the reliability of the components over time.

With the current actuators we can simulate different road stretches to carry out performing tests on our products.





# ENDURANCE TESTS

Beyond design, simulation and laboratory testing, PEI Mobility verify its products directly on the road.

We have chosen IDIADA as a globally recognized partner to carry out the tests on the Spanish endurance-track located in Tarragona.

The tests were performed with very positive results.





# BELLOWS FOR BUSES

Made with the most advanced materials, our bellows feature patented systems that ensure optimum fastening to the carriage body, guaranteeing ultra-smooth movement, greater reliability and increased on-board comfort.

Flexibility and efficiency are also guaranteed by extensive engineering expertise, IATF automotive certification, stringent tests and calculation procedures, together with continuous research and development activities.



PEI Mobility bellows are made of UV-resistant copolymer that complies with the highest safety regulations in the automotive field.

Extensive customisation: in addition to the traditional grey, our bellows are also available in a wide range of colours.





## CUSTOMISATION

Each bellow is designed according to customer's specifications with tailor-made features according to the geometry of the vehicle, both internally and externally.

Technical innovations in the fastening systems allow us to create rounded lines with greater aesthetic appearance and functional comfort for passengers.



The translucent fabric makes a dark area a bright and comfortable space.

Many years of development in fabric technology enable us to offer customised colours according to all customers' needs.

The integrated extension provides the product an exclusive design and ensures unique ease of cleaning.







The constant R&D activity of the PEI Mobility engineering team aims towards increasingly sustainable urban mobility, with solutions designed to guarantee maximum passenger comfort and safety, as well as resistance and ease of maintenance of bus components.

Over the years, PEI Mobility has developed and produced several innovative systems, many of which have been patented:

The fastening of internal bellows to the body and central hoop.

This system allows fast replacement and gives great stability to the structure.

Our innovative patented system for fastening the bellows to the bus carriage offers an ease of installation that is unique on the market and requires also extremely low maintenance.



The special zips reduce the tension of the bottom part fabrics and ensure a more effective sealed area.



The connecting clips between bellows.

The system allows a quick and easy installation, in addition to a reliable and custom-tailored product.





# GUIDING SYSTEMS

PEI Mobility has designed a complete range of options for routing various kinds of cables and lines, like high and low voltage electrical cables, data cables, pneumatic and hydraulic lines, and climate control lines, during vehicle movement.

## HGS: Hoses Guiding System



Internal complete hose guiding system with fixing brackets ready for assembly of all cables between carriages.

This cable chain protects the internal hoses during the vehicle movements: the cables can move freely in the space and are not bound to any guides.





They are Plug&Play preassembled systems, complete with fixing brackets, ready for running cables and lines between the carriages, installable in or outside the vehicle.

## EGS: Energy Guiding System



External hose guiding system, designed for high-voltage cables of electric vehicles with fixing brackets ready for assembly of all cables between carriages.

Our cart handling system with independent axes and cable support is patented, as well as the stabilizing sheet and cable support in deformable sectors made of harmonic steel.

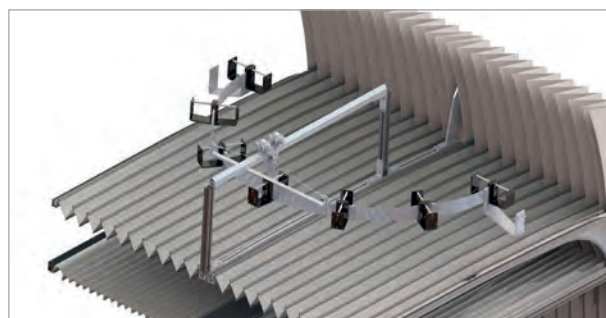



# QUALITY & TESTING

Each new bellow design is tested in our dedicated in-house division, according to the customer's technical specifications, to offer a level of service in line with the quality of our products.

These tests are conducted in compliance with the International Automotive Task Force (IATF) and Verband der Automobilindustrie (VDA - certified process Volkswagen) standards, which are widely recognized and followed in the automotive industry.

Our tests also comply with technical prescriptions concerning construction of certain categories of motor vehicles contained in the UN-Regulation No. R118-2.



## STATIC TEST BENCH

The purpose of a static test bench is to assess the structural integrity, and functional reliability of automotive parts or systems.

It involves subjecting the component or system to static loads, which simulate the forces and stresses that it would experience during normal operation or in various challenging scenarios.

## WATER TESTING

Water testing is a crucial aspect of evaluating the performance and reliability of automotive components and systems.

It helps assess their ability to withstand exposure to water and ensure they meet the required standards and specifications.

## SINGLE DYNAMIC TEST

The single dynamic test is an important step in the testing process for automotive designs. It involves subjecting a prototype or a full-scale model of a vehicle or component to various simulated movements and conditions, as specified by the customer's technical specifications.

During the single dynamic test, the test bench is used to replicate the real-world operating conditions that the design will encounter. This may include simulating movements such as acceleration, braking, turning, and various other manoeuvres. The goal is to evaluate the performance, durability, and safety of the design under these conditions.





**PEI Mobility brand of P.E.I. Srl**

*Headquarter*

Via Torretta 32-32/2-34-36  
40012 Calderara di Reno, Bologna - Italy

*Articulations Plant*

Via Fratelli Rosselli, 11  
40069 Zola Predosa, Bologna - Italy

*Bellows Plant*

**SPER Srl**  
Via Enrico Fermi, 1  
26030 Solarolo Rainerio, Cremona - Italy

T - +39 051 6464811  
E - [info@peimobility.com](mailto:info@peimobility.com)

[www.peimobility.com](http://www.peimobility.com)

rev.11\_24

